

## Whynter 34 Bottle Freestanding Stainless Steel Wine Refrigerator with Display Shelf and Digital Control

Model # : FWC-341TS

### INSTRUCTION MANUAL



Congratulations on your new Whynter product. To ensure proper operation, please read this Instruction Manual carefully before using this product. Keep this manual in a safe place for future reference.

## Table of Contents

---

	<u>PAGE</u>
Safety Precautions	<b>3 - 4</b>
Parts	<b>5</b>
Product Features	<b>6</b>
Important Safety Instructions	<b>7</b>
Operation and Controls	<b>8 - 10</b>
Bottle Storage	<b>11</b>
Care and Maintenance	<b>12 - 13</b>
Troubleshooting	<b>14</b>
Warranty Information	<b>15</b>

---

### APPLIANCE SAFETY

Your safety and the safety of others are very important to us.

To reduce the risk of fire, electrical shock, or injury when using your appliance, follow these basic precautions



This is the Safety Alert Symbol. This symbol alerts you to potential hazards that may result in serious injury. All safety messages will follow the Safety Alert Symbol and either the words "DANGER" or "WARNING".



Danger means that failure to heed this safety statement may result in severe injury or death.



Warning means that failure to heed this safety statement may result in extensive product damage, serious injury, or death.



Caution means that failure to heed this safety statement may result in minor or moderate injury, or property or equipment damage.

All safety messages will alert you to know what the potential hazard is, tell you how to reduce the chance of injury, and let you know what can happen if the instructions are not followed.

### IMPORTANT SAFEGUIDES



Before the appliance is used, it must be properly positioned and installed as described in this manual, please read the manual carefully. To reduce the risk of fire, electrical shock or injury when using the appliance, follow basic precaution, including the following:



- Plug into a grounded 3-prong outlet, do not remove grounding prong, do not use an adapter, and do not use an extension cord.
- Do not use if the power supply cord is damaged. If damaged, it must be replaced by a qualified electrician.
- It is recommended that a separate circuit, serving only your appliance be provided. Use receptacles that cannot be turned off by a switch or pull chain.
- Never clean appliance parts with flammable fluids or harsh chemicals. These fumes can create a fire hazard or explosion.
- Do not store or use gasoline or other flammable vapors and liquids in the vicinity of the appliance or any other appliance.
- Before proceeding with cleaning and maintenance operations, make sure to unplug the appliance.
- Do not connect or disconnect the electric plug with wet hands.
- Do not attempt to repair or replace any part of your appliance unless it is specifically recommended in this manual. All other servicing should be referred to a qualified technician.



### **FOLLOW WARNING CALL OUTS BELOW ONLY WHEN APPLICABLE TO YOUR MODEL**

- Use two or more people to move and install the appliance. Failure to do so can result in injury.
- When positioning the wine refrigerator, ensure that there is at least a 4" clearance at the sides and a 6" clearance at the back.
- **Please note that this is a freestanding appliance and should not be placed into a built-in space. Even with the recommended clearance, there may not be adequate airflow.**
- It is recommended that you install the wine refrigerator in a place where the ambient temperature is between (68°F- 78°F). This appliance must be installed in an area protected from the element, such as wind, rain, water spray or drips.
- The appliance should not be located next to ovens, grills or other sources of high heat.
- The appliance must be installed with all electrical connections in accordance with state and local codes.
- The fuse (or circuit breaker) size should be 15 amperes.
- It is important for the appliance to be leveled in order to work properly. For a stable installation, make sure the appliance is placed on a flat, level and solid surface.
- Ensure that the surface on which the appliance is placed is strong enough to hold the appliance and the items stored inside.
- This appliance is not intended for use by young children or physically-challenged persons without supervision/assistance. Young children must be supervised to ensure safety around this or any appliance.
- Do not use solvent-based cleaning agents or abrasives on the interior. These cleaners may damage or discolor the interior.
- Keep fingers out of the "pinch point" areas. Clearance between the doors and between the doors and cabinet are necessarily small. Be careful closing doors when children are in the area.
- Close the wine refrigerator immediately after putting in any items to keep the internal temperature relatively constant.
- Avoid placing any objects on top of the appliance.
- This is an electrical appliance, to avoid injury from electrical shock do not operate the unit with wet hands, while standing on a wet surface or while standing in water. Do not use outdoors or in wet conditions.
- When positioning or moving the appliance, ensure that it is not turned up side down or unlevelled greater than 45°.
- Never pull the power cord to disconnect it from the outlet. Grasp the plug and pull it from the outlet.
- Never lift, carry or drag the appliance by the power cord.
- This appliance is designed for household, non-commercial use only. Any other use will void the warranty.
- Do not plug into the power outlet before set up is completed.
- Do not cut or remove the ground prong from the power cord.
- Do not move this appliance without emptying it and securing the door in a closed position.

# Parts

SETUP A

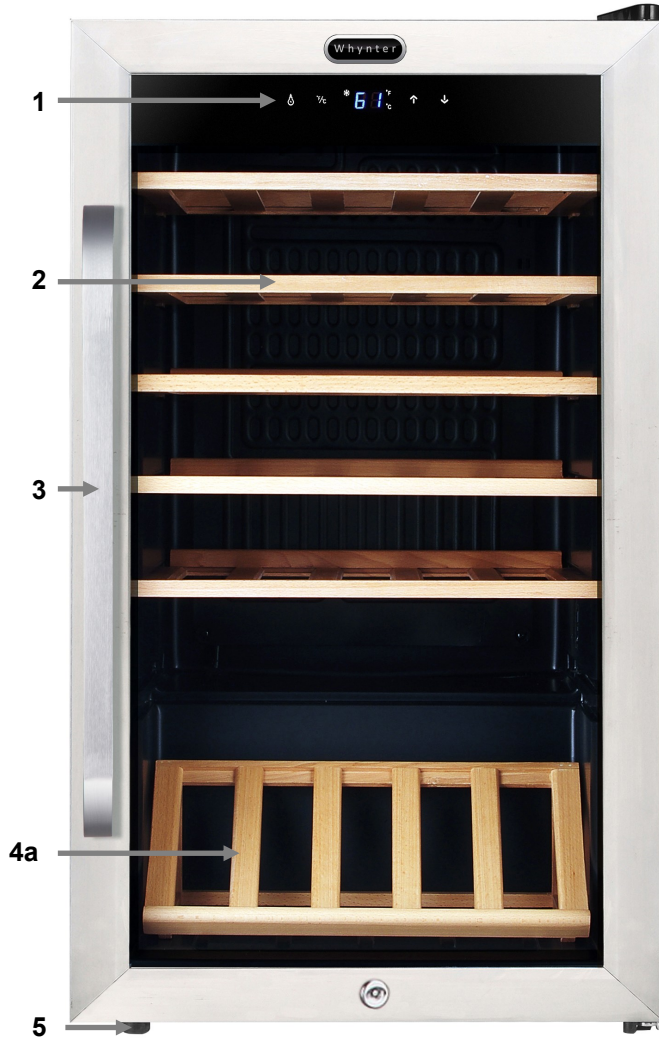

SETUP B



1. Control Panel	8. Door Frame
2. Wooden Flat Shelves 5 for Setup A 6 for Setup B	9. Cylinder Lock
3. Door Handle	10. Door Hinge
4a. Wooden Display Shelf 4b. Wire Gate	11. Small Leveling Leg
5 Large Leveling Leg	12. Drip Tray
6. Door Hinge Cover	13. Power Cord
7. Light and Internal Fan	14. Door Keys

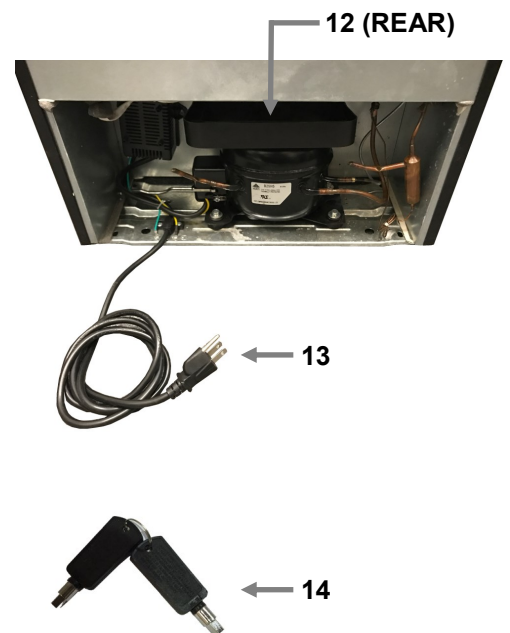

# Product Features

## FEATURES

- 34 standard 750ml wine bottles
- Freestanding installation
- Stainless steel trimmed glass door with sleek black cabinet
- Touch screen control with temperature range from 39°F - 65°F.
- Environmentally friendly refrigerant
- Tempered double pane glass for enhanced UV protection
- Soft interior LED lighting with on/off switch
- Internal fan-forced circulation for even temperature distribution throughout the cabinet
- Cylinder lock and two keys
- Fahrenheit and Celsius degree temperature indicators
- 6 removable wooden flat slide out shelves
- 1 wooden display shelf
- 1 wire gate

### **SETUP A**

- Shelf One through Five: 25 bottles
- Bottom Section: 5 bottles (wooden display shelf installed, 6th shelf removed)



### **SETUP B**

- Shelf One through Six: 30 bottles
- Bottom Section: 4 bottles (wire gate installed)

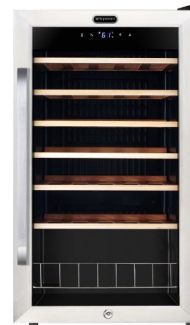

## TECHNICAL DATA

<b>MODEL :</b>	<b>FWC-341TS</b>
Capacity	34 750ml standard wine bottles
Voltage	115V/60Hz
Power Consumption	85W / 1.3A
Temperature Control Range	39°F - 65°F / 4°C - 18°C
Net Weight	61 lbs
Gross Weight	80 lbs
Unit Dimensions	33" H x 19" W x 18.25" D (20" D with handle installed)
Packaging Dimensions	37" H x 22.5" W x 22.5" D
Refrigerant	R600A

## Important Safety Instructions



### WARNING

To reduce the risk of fire, electrical shock, or injury when using your appliance, follow these basic precautions:

- Read all instructions before using the appliance.
  - **DANGER or WARNING:** An empty wine refrigerator can be a hazardous for children or small pets. If disposing of the wine refrigerator, remove gasket seals, latches, lids or the entire door from your unused appliance, or take other action to ensure the appliance is harmless.
- Never allow children to operate, play with, or crawl inside the appliance.
- Never clean appliance parts with flammable fluids or harsh chemicals. The fumes can create a fire hazard or explosion.
- Do not store or use gasoline or any other flammable vapors and liquids in the vicinity of this or any other appliance. The fumes can create a fire hazard or explosion.

### BEFORE USING YOUR APPLIANCE

- Remove the exterior and interior packing.
- Clean the interior surface with lukewarm water using a soft cloth.
- Before connecting the appliance to the power source, let it stand upright for approximately 4 hours. This will reduce the possibility of a malfunction in the cooling system from handling during transportation.

### INSTALLATION OF YOUR APPLIANCE

- **WARNING:** Do not store or install the appliance outdoors.
- **CAUTION:** This appliance is designed for storing and cooling beverages or wine. Do not store perishable food, medicine or other medical products.
- Place your appliance on a hard and level floor that is strong enough to support it when it is fully loaded.
- To level your appliance, adjust the legs(1 large leveling leg and 1 small leveling leg under the door hinge) at the bottom of the appliance if needed.
- When positioning this freestanding wine refrigerator, ensure that there is at least a 4" clearance at the sides and a 6" clearance at the back. Please note that this is a freestanding appliance and should not be placed into a built-in space. Even with the recommended clearance, there may not be adequate airflow.
- We do not recommend installing the appliance on carpet.
- Ensure that the condensation tube is directed into the drip tray located at the back of the unit to prevent leakage.
- Do not install the appliance near an oven or other heating source. Direct sunlight may affect the acrylic coating and heat sources may increase electrical consumption. For best performance, do not install the appliance behind a cabinet door. Extreme cold ambient temperatures may also cause the appliance not to perform properly.
- Avoid locating the appliance in area that may be exposed to excessive moisture.
- Plug in the appliance into an exclusive, grounded wall power outlet. Do not under any circumstances cut or remove the third (ground) prong from the power cord. Any questions concerning power and/or grounding should be directed toward a qualified electrician or an authorized service center.

### ELECTRICAL CONNECTION

This appliance requires a standard 115/120 Volt AC ~/60Hz electrical ground outlet with three-prong. Have the wall outlet and circuit checked by a qualified electrician to make sure the outlet is properly grounded. The cord should be secured behind the appliance and not left exposed or dangling to prevent accidental injury. The appliance should always be plugged into its own individual electrical outlet which has a voltage rating that matches the rating label on the appliance. This provides the best performance and also prevent overloading house wiring circuits that could cause a fire hazard from overheated. Never unplug the appliance by pulling the power cord. Always grip the plug firmly and pull straight out from the receptacle. Repair or replace immediately all power cords that have become frayed or otherwise damaged. Do not use a cord that shows cracks or abrasion damage along its length or at either end. When moving the appliance, be careful not to damage the power cord.

### EXTENSION CORD

Because of potential safety hazards, it is strongly recommended that you do not use an extension cord with this appliance. However, if you must use an extension cord, it is absolutely necessary that it be a UL/CUL-Listed, 3-wire grounding type appliance extension cord having a grounding type plug and outlet and that the electrical rating of the cord be 115 volts and at least 10 amperes.

# Operation and Controls

## OPERATING THE WINE REFRIGERATOR

### Recommend Temperature Settings

Conservation	49 - 57°F
Red Wines	62 - 72°F
Dry/White Wines	48 - 57°F
Rose Wines	49 - 51°F

It is recommended that you install the wine refrigerator in a place where the ambient temperature is between (68°F - 78°F). If the ambient temperature is above or below recommended temperatures, the performance of the unit may be affected. For example, placing in extreme cold or hot conditions may cause interior temperature to fluctuate thus the set temperature may not be achievable.

## CONTROL PANEL



## SETTING THE TEMPERATURE

The temperature range can be set between 39°F - 65°F (4°C - 18°C). To set the desired temperature, press the ↓ button to lower the temperature or ↑ button to raise the temperature on the control panel. The temperature display will flash for 5 seconds indicating that the desired temperature is set and will revert back to its actual internal temperature.

### NOTE:

- The temperature inside the wine refrigerator is dependent on the ambient temperature (room temperature).
- The ❄️ cooling icon is illuminated when the cooling cycle unit is in operation. Once the unit reaches the set temperature, the cooling icon will shut off.

## INTERIOR LIGHT / °C and °F SELECTOR

You can turn on and off the interior light by pressing the 💡 Light button on the control panel. To change temperature conversions, press the °F/°C button to switch between temperature conversions.

## LEVELING THE APPLIANCE

It is important for your appliance to be leveled in order to work properly. It can be raised or lowered by rotating each of the feet on the bottom of the machine. If you find that the surface is not level, rotate the feet until the appliance becomes level. You may need to make several adjustments to level it. We recommend using a carpenter's level to check the machine.

**NOTE:** *The Whynter FWC-341TS has 1 large leveling leg and 1 small leveling leg under the door hinge.*

1. Place a carpenter's level on top of the product to see if the appliance is level from front to back and side to side.
2. Adjust the height of the feet as follows: Turn the leveling feet to the right to lower that side of the refrigerator. Turn the leveling feet to the left to raise that side of the refrigerator.

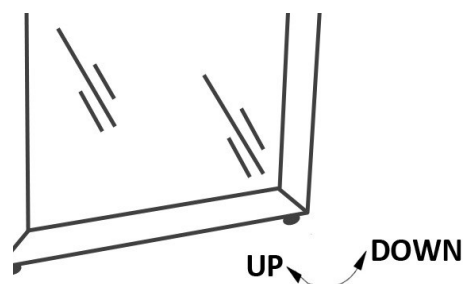



## Operation and Controls

### **INSTALLING STAINLESS STEEL HANDLES**

This appliance includes stainless steel handles that are not required to operate this appliance. To install the handles please follow the below instructions:

1. The gaskets are easily displaced by hand, no tools are necessary.
2. Use a flat-head screwdriver to remove the two pre-installed decorative plugs from the back of doors. Some wine refrigerators have no decorative plugs.
3. Install the handles tightly as shown with two screws, lock washers and flat washers provided. (DO NOT over tighten as this will cause damage to the handles and stainless steel door frames).
4. Replace the door gaskets to its original position.

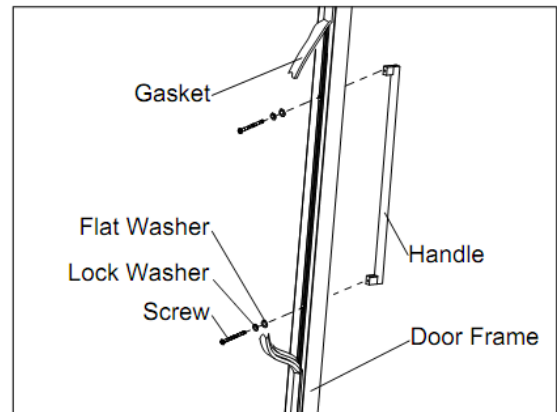

### **WINE SHELVES**

This wine refrigerator is equipped with 6 wooden removable shelves. To prevent damage to the door gasket, ensure the door is opened completely before sliding the shelves out.

- To easily access the stored wine bottles, pull the shelves approximately  $\frac{1}{3}$ " out of the railing.
- When removing the shelves from of the railing, make sure all items are first removed.
- To remove any of the shelves from the rail compartment, move the shelf to the position where the notch of shelf is exactly under the plastic post and then lift it up and out.
- If the wine bottles are stored horizontally in the bottom section of the cabinet, ensure that the wire gate is installed to secure and prevent bottles from rolling out.
- A maximum number of 5 wooden shelves can be utilized if the bottom wooden display shelf is used.

### **STORAGE**

Wine bottles may differ in size and dimensions so the actual number of bottles that can be stored may vary. The 34 bottle capacity is an approximate maximum when storing traditional 750 ml bottles and includes bulk storage.

- You may load your wine bottles in single row or by stacking while taking note of the following: if you do not have enough bottles to fill your wine refrigerator, it is better to distribute the load throughout the wine refrigerator so as to avoid "all on top" or "all below" type loads.
- You can remove or relocate adjustable shelves to accommodate larger type of bottles.
- Keep small gaps between the walls and the bottles to allow air circulation.
- Do not cover any part of the shelves with aluminum foil or any other material that will prevent adequate air circulation within the cabinet.
- Do not over load your wine refrigerator.
- Avoid obstructing the internal fan (located inside on the top panel of the wine refrigerator).
- Do not try to slide the shelves outwards beyond the fixed position to prevent the bottles from falling.
- Do not pull out more than one loaded shelf at a time as this may cause the wine refrigerator to tilt forward if not properly installed.

### **NORMAL SOUNDS**

The unit is cooled by a compressor. The compressor pumps coolant through the cooling system, producing operating noise. Even when the compressor cuts out, noises caused by changes in temperature and pressure are unavoidable. Operating noise will be most audible immediately after the compressor comes on. It becomes quieter as the operating period continues.

The following noises are normal and occur from time to time:

- Gurgling sound, caused by the refrigerant flowing through the appliance's coils.
- Humming noise made by the compressor. This noise can get louder for brief periods when the motor is switching on.
- Cracking/popping sounds, resulting from the materials contraction and expansion due to temperature variations.
- Fan operating sound, to circulate the air within the wine cabinet.
- Unusual noise is normally the result of improper installation.
- Where the unit is installed in open-plan kitchen or in partition walls, the level of operating noise will be heard more acutely. However, this is due to the surrounding architecture and not to the unit.

**NOTE:** *An individual's perception of noise is directly linked to the environment in which the unit is located, as well the specific type of models. Our appliances are in line with international standards for such appliance and in line with the latest technical developments. Please remember that the noise of the compressor and the coolant circulating in the system is unavoidable.*

## Bottle Storage

### 30 BOTTLES LOADING PLAN (6th shelf removed, wooden display shelf used)

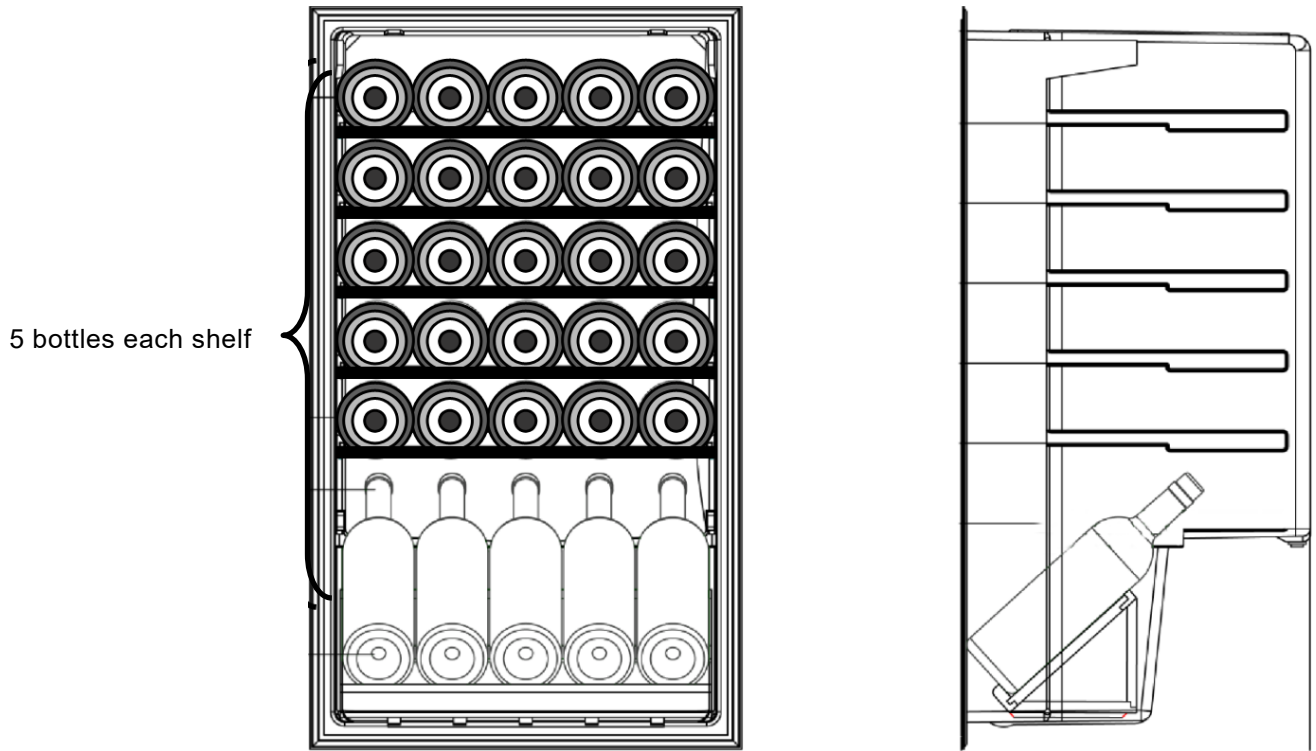

### 34 BOTTLES LOADING PLAN (6 wooden shelves, wire gate installed)

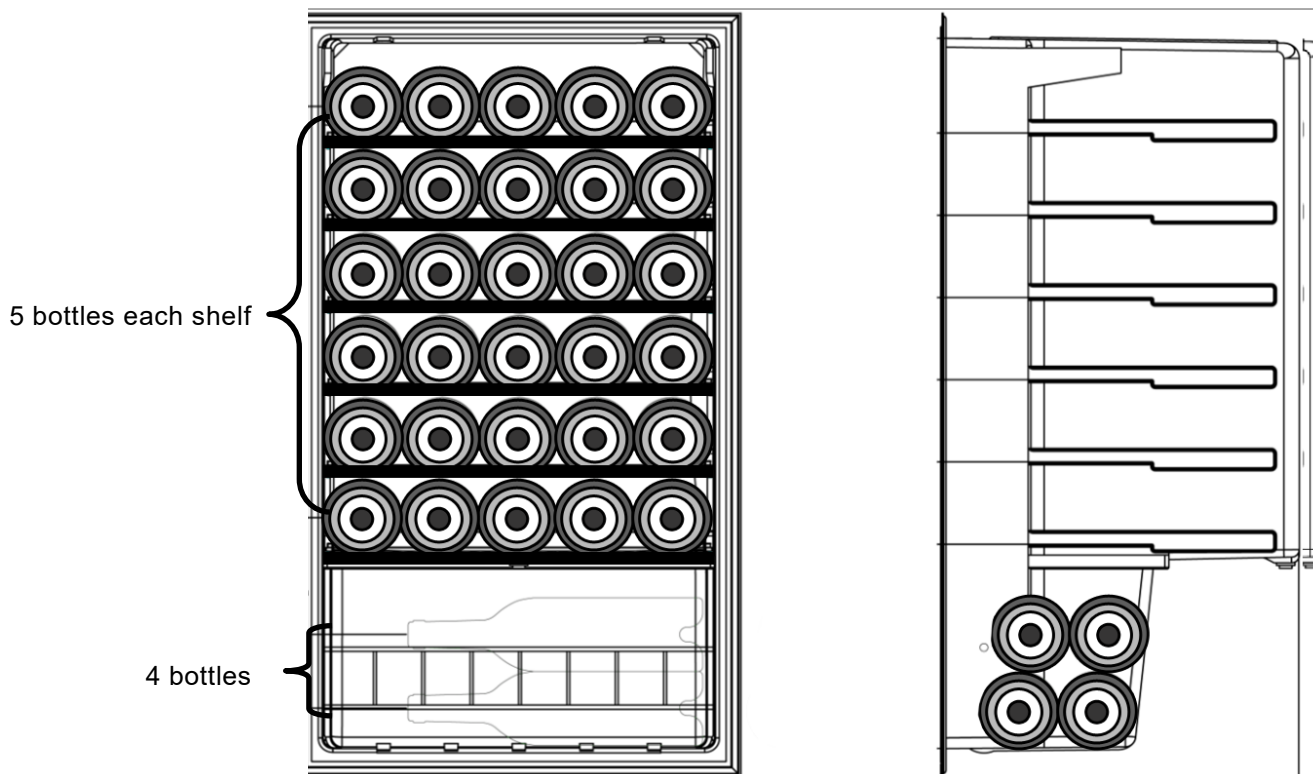

## Care and Maintenance

### CLEANING YOUR APPLIANCE

- Turn off the power, unplug the appliance, and remove all contents from the appliance and store them in a suitable place.
- Clean the inside, the door seal and the inside of the glass with a clean, damp cloth.
- Never use detergents or other substances that emit odors.
- Always keep the door closed when cleaning the outside of the appliance. Make sure no detergent odors penetrate into the appliance.
- Clean the side panels and door surfaces with a clean and soft cloth. If necessary, use a moist cloth. Alternatively, use a microfiber cloth.
- The humidity tray should be hand-washed with water and detergent. After cleaning, always make sure the tray is thoroughly rinsed with clean water before replacing.

### PREMISES POWER FAILURE

- In the event of a power interruption, temperature settings automatically defaults to factory settings once power is restored.
- Factory default temperature setting is 53°F. To set a different desired temperature, refer to the "SETTING THE TEMPERATURE" and "°C and °F SELECTOR" section on page 8.
- Most power failures are corrected within a few hours and should not affect the temperature of your appliance if you minimize the number of times the door is opened. If the power is going to be off for a longer period of time, you need to take the proper steps to protect your contents.

### VACATION TIME

- Short vacations: Leave the appliance operating during vacations of less than two days.
- Long vacations: If the appliance will not be used for an extended period, remove all items and turn off the appliance. Clean and dry the interior thoroughly.

### MOVING YOUR APPLIANCE

- Remove all items inside the appliance.
- Securely tape down (we recommend using painter's tape) all loose items (shelves) inside your appliance.
- Turn the adjustable legs up to the base to avoid damage.
- Tape (we recommend using painter's tape) the door shut.
- Be sure the appliance stays secure in the upright position during transportation and protect the exterior of appliance with a blanket, or similar item.

### PREPARING FOR STORAGE

If the wine refrigerator will not be used for a long time, or is to be moved to another place, it will be necessary to defrost the unit and dry the interior.

1. Disconnect the wine refrigerator from the power supply by removing the power plug from the wall socket.
2. Leave the door open to allow for air circulation and to prevent mold, mildew and unpleasant smells.

**CAUTION: Store the unit out of the reach of children. If you have children, you may want to take additional precautions such as removing the door to prevent a child from being trapped inside the wine refrigerator**

#### NOTE:

- *If the wine refrigerator is unplugged, encounter power lost, or turned off; you must wait 3 to 5 minutes before restarting the wine refrigerator.*

## Care and Maintenance

- *When the wine refrigerator is used for the first time or restarted after having been shut off for a long time, there could be a few degrees variance between the temperature you select and the one indicated on the display. This is normal and it is due to the length of the inactivation time.*

### **ENERGY SAVING TIPS**

- The appliance should be located in the coolest area of the room, away from heat producing appliances, and out of any direct sunlight.
- Ensure that the appliance is adequately ventilated. Never obstruct the air vents.
- Close the door tightly and do not open the appliance too frequently or for a long period of time.
- Store the content in an organized way.
- Do not over load the appliance to allow air to circulate.

### **TRANSPORT OF THE WINE REFRIGERATOR**

The ideal packaging for the wine refrigerator is its original packaging. Please keep the original packaging handy and repack the wine refrigerator if you need to transport the unit.

### **DEFROSTING**

Under most ambient conditions, the wine refrigerator does not need to be defrosted. In cold ambient temperatures and/or high humidity, some frost may build up. To defrost, remove all items, unplug the wine refrigerator and leave the door open. Never use a knife or other metal instrument to scrape ice/frost. After defrosting, plug in the wine refrigerator and set the desired temperature.

## Troubleshooting

Problem	Possible Causes	Solutions
The appliance does not operate	<ul style="list-style-type: none"> <li>• There is a power failure.</li> <li>• The appliance is not plugged in.</li> <li>• A house fuse has blown or the circuit breaker is tripped.</li> </ul>	<ul style="list-style-type: none"> <li>• Ensure the appliance is plugged in and the power outlet has power.</li> <li>• Replace the broken fuse or reset the breaker.</li> </ul>
The appliance is not reaching the desired temperature	<ul style="list-style-type: none"> <li>• The appliance is placed too close to a heat source</li> <li>• The door is opened too often.</li> <li>• The door is not closed completely.</li> <li>• The door gasket does not seal properly.</li> </ul>	<ul style="list-style-type: none"> <li>• Adjust the temperature.</li> <li>• Keep the appliance away from sunshine or other heat sources.</li> <li>• Close the door tightly and do not open the door too frequently or for a long period of time.</li> <li>• Ensure the door gasket is not loose..</li> </ul>
Frost forming inside the appliance	<ul style="list-style-type: none"> <li>• The environment is too humid.</li> <li>• The ambient temperature is too low.</li> <li>• The door is opened too frequently for a long period of time.</li> <li>• Items are blocking the internal fan.</li> </ul>	<ul style="list-style-type: none"> <li>• Although this unit uses an auto-defrost system, under certain conditions, manual defrosting may required. If frost builds up, try running the unit on a warmer temperature setting.</li> <li>• Close the door tightly and do not open the door too frequently or for a long period of time.</li> <li>• Unplug the unit to allow the frost to melt.</li> <li>• Move items so they do not block the fan.</li> </ul>
Condensation builds up on the glass door.	<ul style="list-style-type: none"> <li>• Ambient temperature or humidity is high.</li> </ul>	<ul style="list-style-type: none"> <li>• Lower the room humidity by a dehumidifier or air conditioner.</li> </ul>
The appliance turns itself on and off frequently	<ul style="list-style-type: none"> <li>• The ambient (room) temperature is too low or high.</li> <li>• A large amount of contents has been added to the appliance.</li> <li>• The door is opened too often.</li> <li>• The door is not closed completely.</li> <li>• The door gasket does not seal properly.</li> </ul>	<ul style="list-style-type: none"> <li>• Decrease or increase the ambient (room) temperature.</li> <li>• To minimize internal temperature fluctuation, do not add large amount of contents at once.</li> <li>• Close the door tightly and do not open the door too frequently or for a long period of time.</li> <li>• Ensure the door gasket is not loose.</li> </ul>
The appliance makes too much noise	<ul style="list-style-type: none"> <li>• If the noise is from the fan, it may be normal operating noise.</li> <li>• Contraction and expansion of the inside walls may cause popping and crackling noises.</li> <li>• The appliance is not level.</li> </ul>	<ul style="list-style-type: none"> <li>• The fan makes normal fan noises.</li> <li>• Some popping or cracking noises are normal. They are caused by expansion and contraction of the inside walls due to temperature changes.</li> <li>• Make sure the unit is on a hard and level surface. Do not place the appliance on carpet.</li> <li>• See Normal Sounds</li> </ul>
The door does not close properly	<ul style="list-style-type: none"> <li>• The appliance is not level.</li> <li>• The door was reversed and not properly installed.</li> <li>• The shelves are out of position .</li> </ul>	<ul style="list-style-type: none"> <li>• Make sure the appliance is on a hard and level surface. Avoid placing the appliance on a carpeted or soft surface.</li> <li>• Reinstall door.</li> <li>• Correctly install the shelves.</li> </ul>

# **ONE YEAR LIMITED WARRANTY**

This Whynter Freestanding Wine Refrigerator is warranted, to the original owner within the 48 continental states, for one year from the date of purchase against defects in material and workmanship under normal use and service. Should your Whynter Freestanding Wine Refrigerator prove defective within one year from the date of purchase, return the defective part or unit, freight prepaid (within two months of purchase; after two months to one year, customer will be responsible for freight cost to Whynter's service department), along with an explanation of the claim to Whynter LLC. Please package the Whynter Freestanding Wine Refrigerator carefully in its original packaging material to avoid damage in transit. Please retain the original box and packaging material. Under this warranty, Whynter will repair or replace any parts found defective. This warranty is not transferable. After the expiration of the warranty, the cost of labor and parts will be the responsibility of the original owner of the unit.

## **THIS WARRANTY DOES NOT COVER:**

- Acts of God, such as fire, flood, hurricanes, earthquakes and tornadoes.
- Improper power supply such as power surge, low voltage, defective household wiring or inadequate fuses.
- Use in commercial or industrial applications
- Damage, accidental or otherwise, to the wine refrigerator while in the possession of a consumer not caused by a defect in material or workmanship;
- Damage caused by consumer misuse, tampering, or failure to follow the care and special handling provisions in the instructions.
- Damage to the finish of the case, or other appearance parts caused by wear.
- Damage caused by repairs or alterations to the product by anyone other than authorized by the manufacturer.
- Removal, Replacement Packaging, Freight and Insurance cost for the warranty service.

### **DISCLAIMER OF IMPLIED WARRANTIES; LIMITATION OF REMEDIES**

*CUSTOMER'S SOLE AND EXCLUSIVE REMEDY UNDER THIS LIMITED WARRANTY SHALL BE PRODUCT REPAIR OR REPLACEMENT AS PROVIDED HEREIN. CLAIMS BASED ON IMPLIED WARRANTIES, INCLUDING WARRANTIES OF MERCHANTABILITY OR FITNESS FOR A PARTICULAR PURPOSE, ARE LIMITED TO ONE YEAR OR THE SHORTEST PERIOD ALLOWED BY LAW, BUT NOT LESS THAN ONE YEAR. WHYNTER SHALL NOT BE LIABLE FOR CONSEQUENTIAL OR INCIDENTAL DAMAGES SUCH AS PROPERTY DAMAGE AND INCIDENTAL EXPENSES RESULTING FROM ANY BREACH OF THIS WRITTEN LIMITED WARRANTY OR ANY IMPLIED WARRANTY. SOME STATES AND PROVINCES DO NOT ALLOW THE EXCLUSION OR LIMITATION OF INCIDENTAL OR CONSEQUENTIAL DAMAGES, OR LIMITATIONS ON THE DURATION OF IMPLIED WARRANTIES, SO THESE LIMITATIONS OR EXCLUSIONS MAY NOT APPLY TO YOU. THIS WRITTEN WARRANTY GIVES YOU SPECIFIC LEGAL RIGHTS. YOU MAY ALSO HAVE OTHER RIGHTS THAT VARY FROM STATE TO STATE.*

Please retain the original proof of purchase in order to obtain warranty services.  
Warranty begins from the original date of purchase.

To obtain service or information, contact  
Whynter LLC via email at [support@whynter.com](mailto:support@whynter.com) or call  
866-WHYNTER.

Product contents and specifications may change without notice.  
Copyright © 2023 Whynter LLC  
[WWW.WHYNTER.COM](http://WWW.WHYNTER.COM)